

# MACRO SEGREGATION CONTROL IN STEEL INGOTS

## Examples and Applications

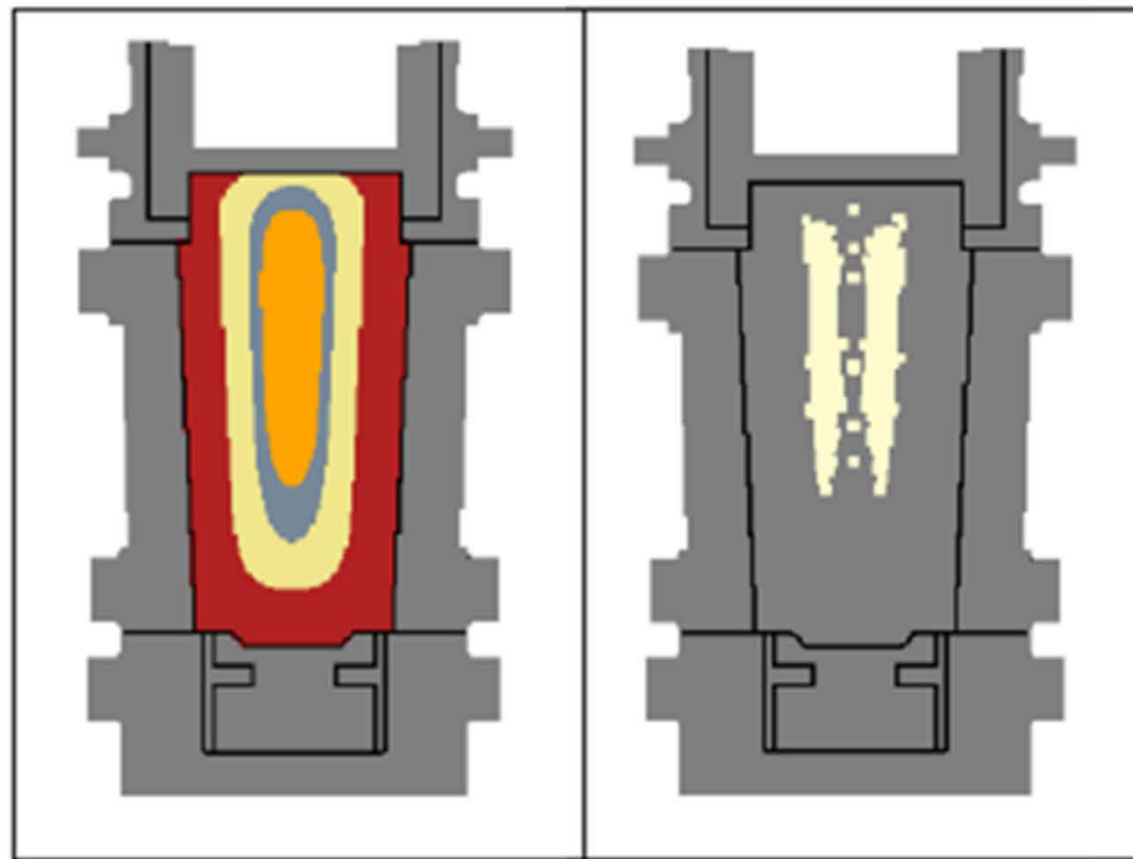

by Ovidiu Bogdan  
bogdan@castingsnet.com

**Industrial Soft**, Montreal, Canada  
[www.castingsnet.com](http://www.castingsnet.com)

# CONTENT

1 Macro Segregation in Steel Ingots

2 Solidification Software

3 Macro Segregation Prediction Technique

4 Examples and Applications

- Research and development
- Control of macro segregation area size
- Macro segregation prediction and manufacturing costs
- Steelmaking shop
- Quality control
- Steel ingots acquisition

5 Macro Segregation Control Service

# 1 Macro Segregation in Steel Ingots

This technique refers to A segregation, commonly known as macro segregation.

A segregation presents channels enriched by sulfur, phosphorus and carbon in the zone of columnar grains at the regions with a structure characterized by transition from the columnar grains to large equiaxed grains.

Macro segregation in steel ingot has as result defects detected by ultrasonic testing and heterogeneity of mechanical properties.

This presentation provides a short description of tools we use to control macro segregation process: solidification simulation software and segregation prediction module. Then, a few examples demonstrate how and where are useful the results and, at the end, the services we offer based on macro segregation control technique

## 2 Solidification Simulation Software

The simulation software employed to simulate the solidification process is **SimCADE v.2.0**, a software developed by Industrial Soft using finite element method.

The software takes into account initial temperatures and thermo physical properties of all materials: steel poured, refractory bricks and mold material data.

The next page presents several applications to demonstrate the possibilities of heat transfer and solidification simulation software we use.

First example shows solidification curves of a steel ingot and macro segregation simulation. Second example simulates the axial porosity in a steel ingot.

Third example shows simulation of porosity in steel castings and the last one, an application in heat treatment area.

# Solidification Simulation Software Examples

Solidification curves

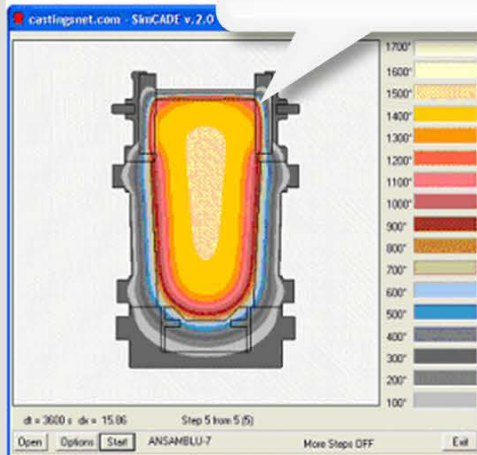

Macro segregation

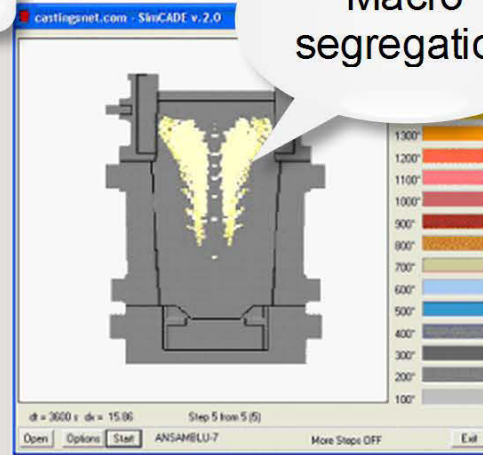

Ingot Solidification - Macro segregation prediction

Axial porosity

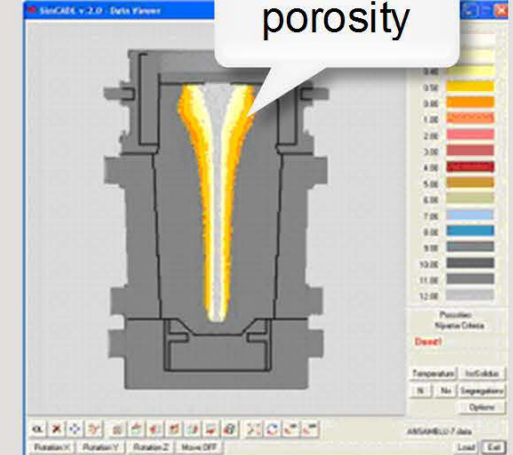
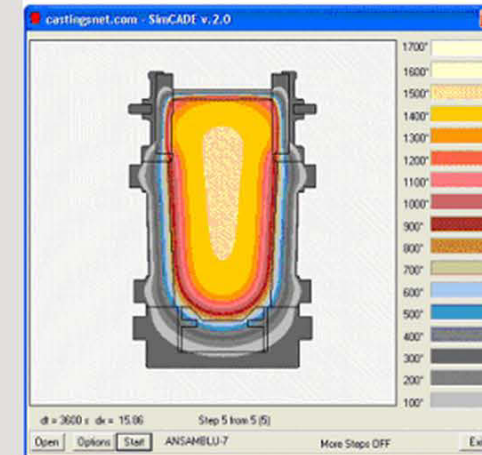

Ingot Solidification - Porosity prediction

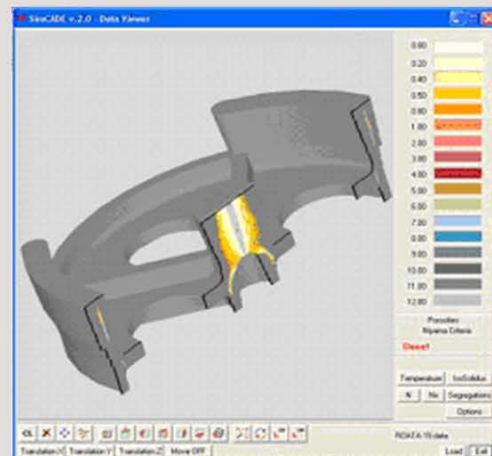
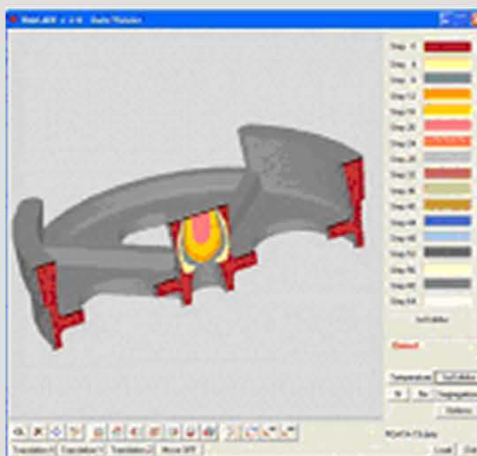

Castings Solidification - Porosity prediction



Superficial heat transfer simulation



### 3 Macro Segregation Prediction Technique

Macro segregation prediction module of the software is based on Suzuki and Miyamoto criterion, a criterion that is presently the most used criterion to predict A-segregation in steel ingots.

The solidification simulation software SimCADE v.2.0 calculates the cooling and solidification rate by simulation, compares it against Suzuki and Miyamoto criterion value and plots the macro segregation area in regions that contain values below a critical value.

Suzuki and Miyamoto criterion is a local thermal parameter defined as:

$$\varepsilon \mathbf{R}^{1.1} \leq \alpha$$

where  $\varepsilon$  is cooling rate and  $\mathbf{R}$  is solidification rate.

See the next page for macro segregation prediction technique flow chart.

# Macro Segregation Prediction Technique



Ingot Geometry Data

Steel Chemical Composition

C, Si, Mn, P, S, Ni, Cr, Mo, V



$\epsilon R^{1.1}$  Distribution

$\epsilon$  - cooling rate  
R - solidification rate

$\alpha = f(C, Si, Mn, P, S, Ni, Cr, Mo, V)$

Calculation of  $\alpha$  ( $\epsilon R_{crt}$  critical)

Solidification Software

Macro segregation on longitudinal section

$\epsilon R^{1.1}$  distribution at 1/2 height

$\epsilon R^{1.1}$  vs.  $\alpha$

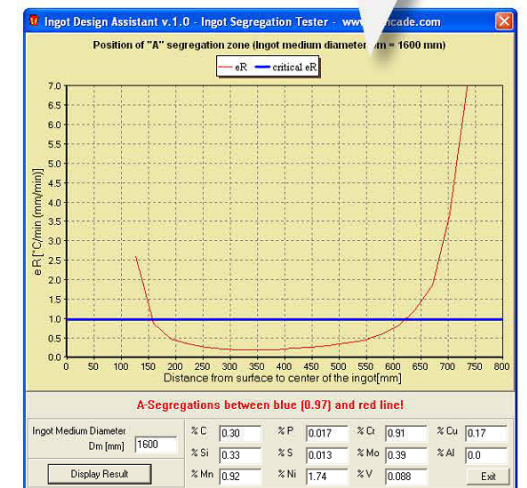
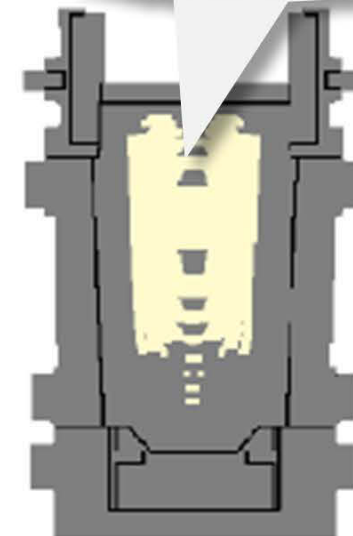
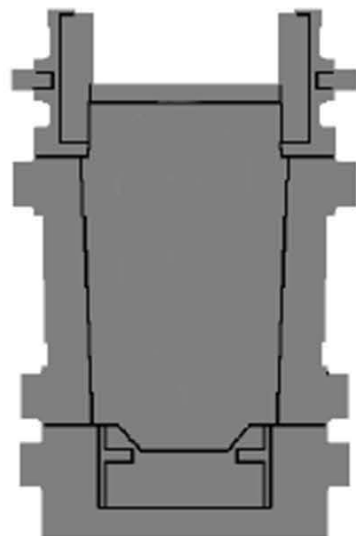
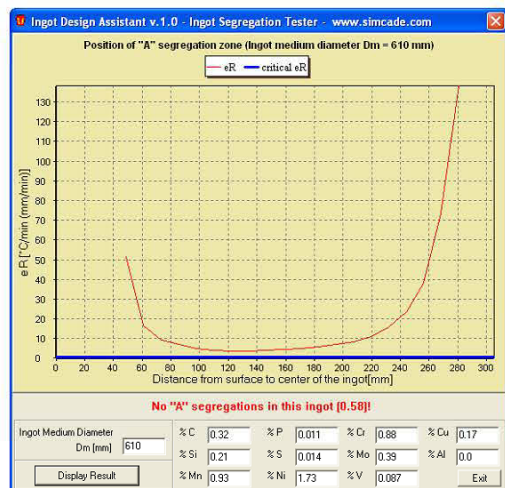

NO Segregation ( $\epsilon R^{1.1} > \alpha$ )

Segregation ( $\epsilon R^{1.1} < \alpha$ )

## 4.1 Using Macro Segregation Prediction in Research and Development

Using the principle mentioned above we made numerical experiments to analyze influence of manufacturing parameters on macro segregation in a 50T AISI4340 ingot steel.

In these experiments we analyzed influence of casting technology variables, mold geometry, and chemical composition of steel on macro segregation.

From the first category of variables we analyzed the hot top size, from the second one H/D ratio and from last one the influence of Si content on macro segregation area size.

Next page shows the simulation of macro segregation in all experiments we made.



# Applications in Research and Development

Casting Technology, Mold Design and Ingot Chemical Composition Analysis  
50T ingot - AISI 4340 steel



Ingot Weight	Medium Diameter	Body Height	H/D ratio	Taper Ratio
50 tons	1700 mm	2250 mm	1.5	9.0 %

Table 1. Chemical composition of AISI 4340 steel

%C	%Si	%Mn	%P	%S	%Cr	%Mo	%Ni
0.36~ 0.44	0.10~ 0.35	0.45~ 0.70	max 0.040	max 0.035	1.00~ 1.40	0.20~ 0.35	1.30~1.70

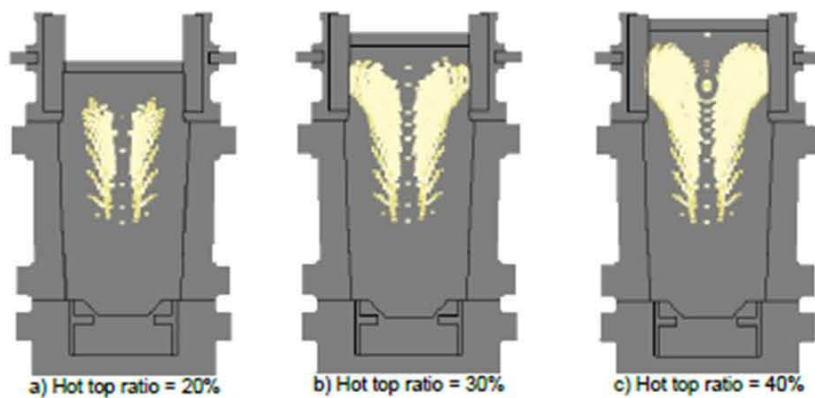

A Segregation zone function by hot top size

**Influence of casting technology on macro segregation**

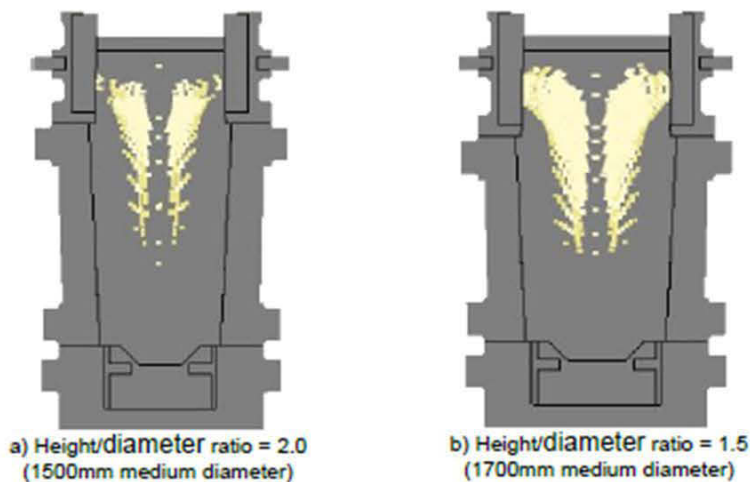

A Segregation zone function by H/D ratio

**Influence of ingot geometry and mold design on macro segregation**

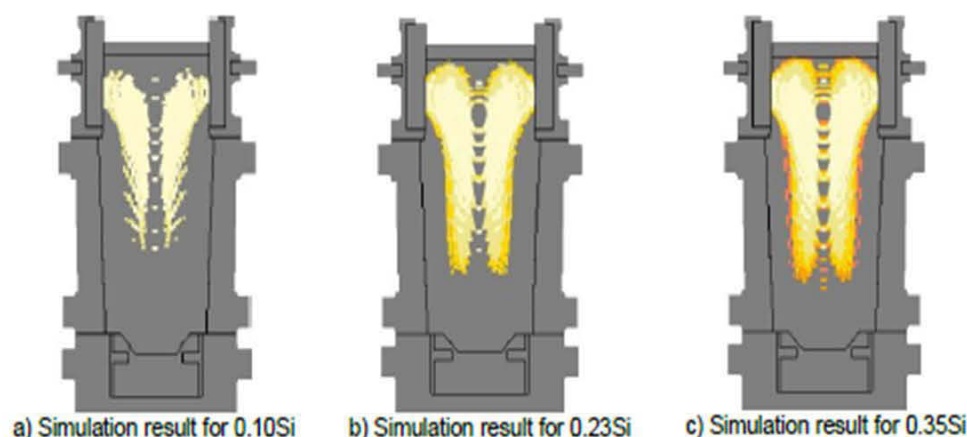

Si content between 0.10Si and 0.35Si

**Influence of chemical composition on macro segregation**

## 4.2 Macro Segregation Prediction and A-Segregation Area Size

The following example is about how to use the macro segregation prediction for minimizing macro segregation area size in technology conception stage.

In this example we assume that there are available three types of molds with H/D ratio 1.0, 1.5 and 2.0. Macro segregation obtained by simulation is given in the first set of diagrams. From the analyzed ingot types, we choose the ingot with H/D ratio 2.0, ingot with the lower segregation area.

The segregation area can be reduced more by increasing Mo and reducing Si content.

Using the quick method,  $\epsilon R$  distribution at 1/2 ingot height level, the diagrams on the next page shows the segregation area in all experiments made.



# 50T ingot - AISI 4340 steel

Table 1. Chemical composition of AISI 4340 steel

%C	%Si	%Mn	%P	%S	%Cr	%Mo	%Ni
0.36~ 0.44	0.10~ 0.35	0.45~ 0.70	max 0.040	max 0.035	1.00~ 1.40	0.20~ 0.35	1.30~1.70

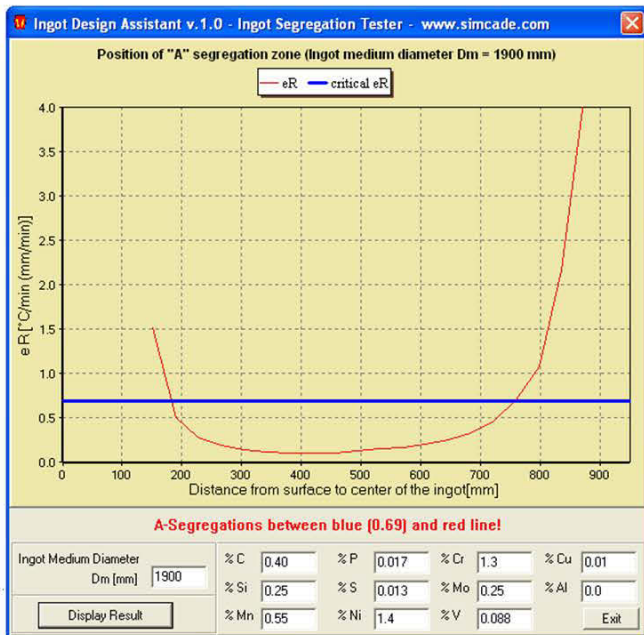
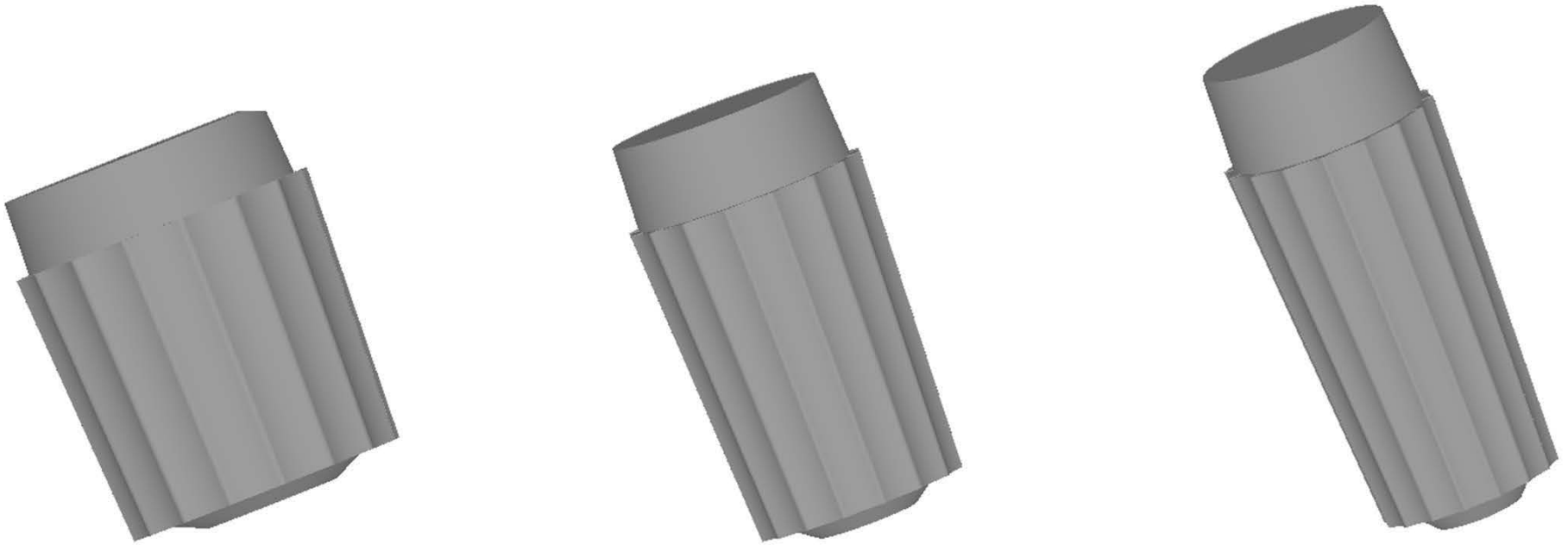

H/D=1.0

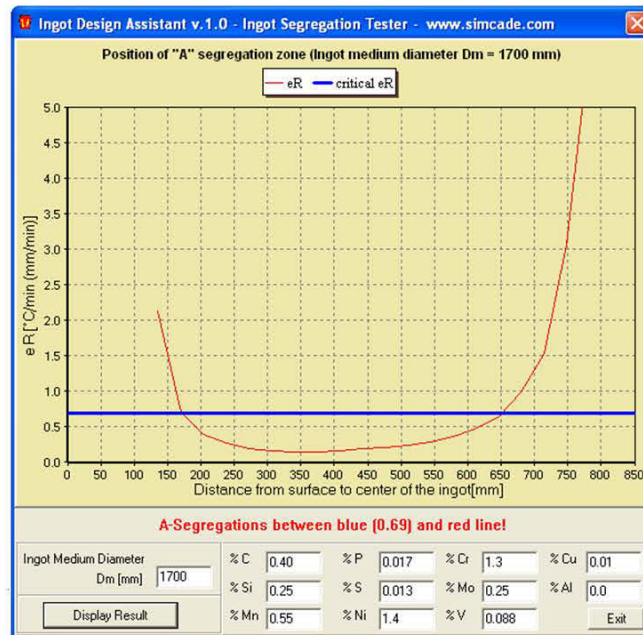

H/D=1.5

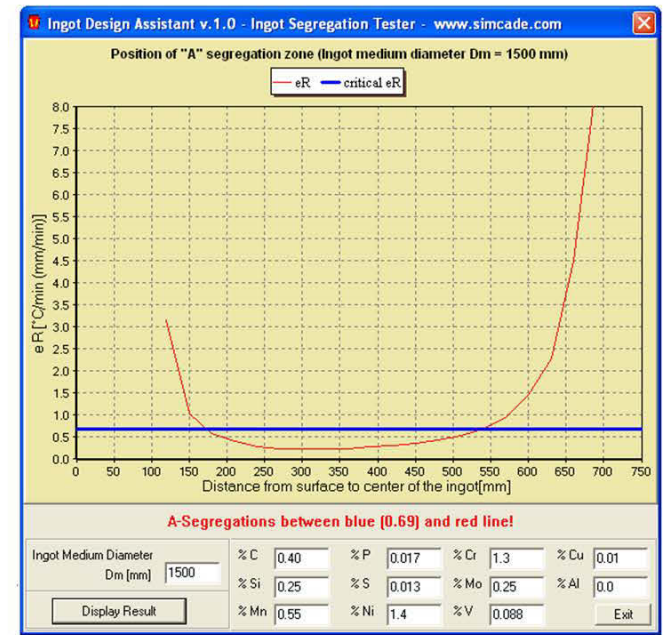

H/D=2.0

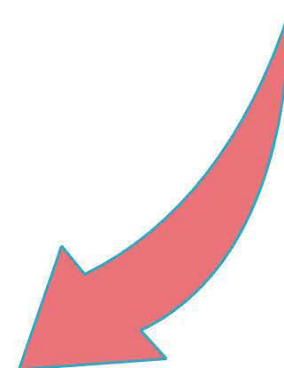
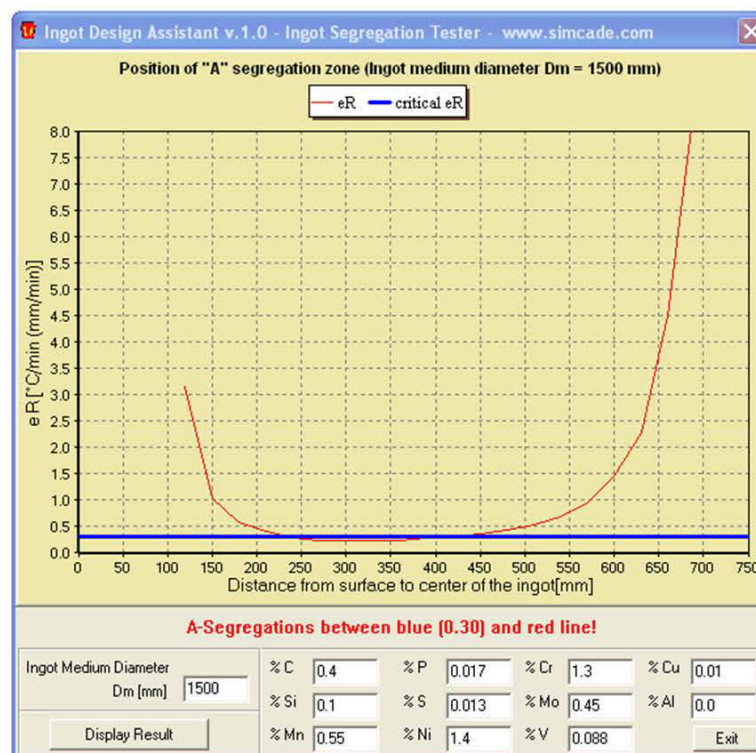

Si 0.10%  
Mo 0.45%

## 4.3 Macro Segregation Prediction and Manufacturing Cost

The following example is another application in technology conception stage. A 5.3T 35NCD16 steel ingot with a given geometry has been taken into consideration.

After simulation and A segregation prediction we find out there is not segregation even if the Mo content is at minimum value allowed by steel specification. This suggests that we can lower manufacturing cost of the ingot by lowering Mo content of steel.

The table on the next page is an estimation about how much we can save if we use a lower Mo content.



# 5.3T Ingot - 35NCD16 Steel

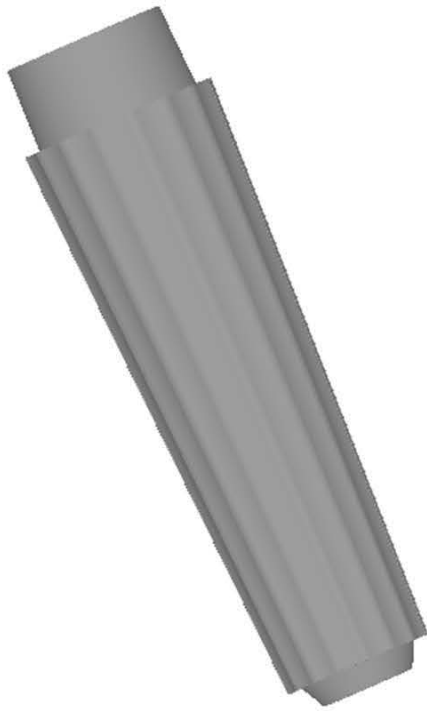

Geometry data of the ingot

Medium Width [mm]	Body Height [mm]	H/D ratio	Taper Ratio [%]
570	2330	4.0	7.00

Table 1. Chemical composition of 35NCD16 steel

%C	%Si	%Mn	%Cr	%Mo	%Ni
0.32~ 0.39	0.10~ 0.40	0.30~ 0.60	1.60~ 2.00	0.25~ 0.45	3.60~4.1

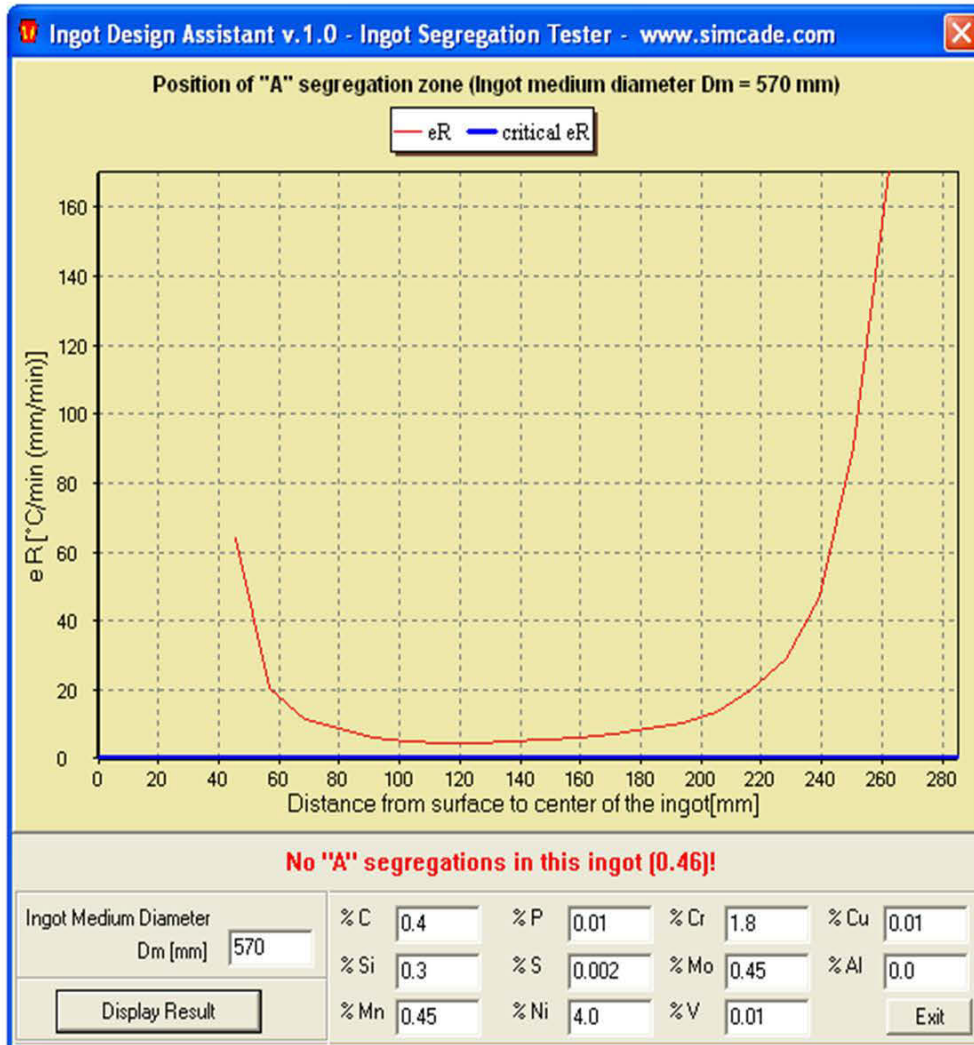

Mo 0.45%

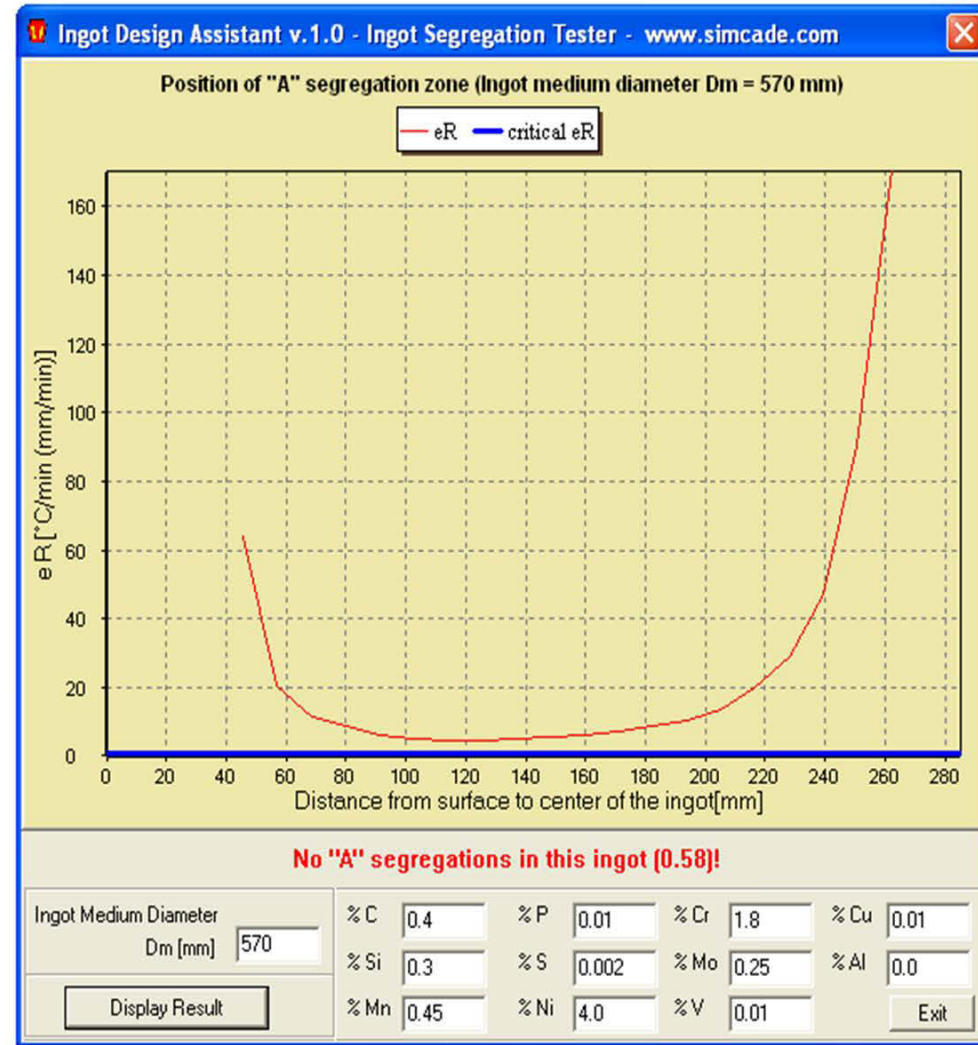

Mo 0.25%

Steel	C	Si	Mn	P	S	Ni	Cr	Mo	V	Manufacturing Cost	
										per ton	per 45T heat
Mo 0.45	0.40	0.30	0.45	0.012	0.006	4.00	1.80	0.45	0.10	\$2726	\$122652
Mo 0.25	0.40	0.30	0.45	0.012	0.006	4.00	1.80	0.25	0.10	\$2589	\$116502
<b>Saving</b>										<b>\$137</b>	<b>\$6150</b>



## 4.4 Macro Segregation Control in Steelmaking Shop

The following example demonstrates how to use the macro segregation prediction in steel making shop.

Steel making process is sometimes unpredictable and may be situations when we cannot control the content of silicon, sulfur or phosphorus. Using macro segregation prediction we find out that in the programmed ingot will be macro segregation at an unacceptable level.

In this situation, we have two options to avoid them, either increase Mo content or simply, change destination of steel by using a smaller ingot.

# Application in Steelmaking Shop

50T heat - 35NCD16 steel

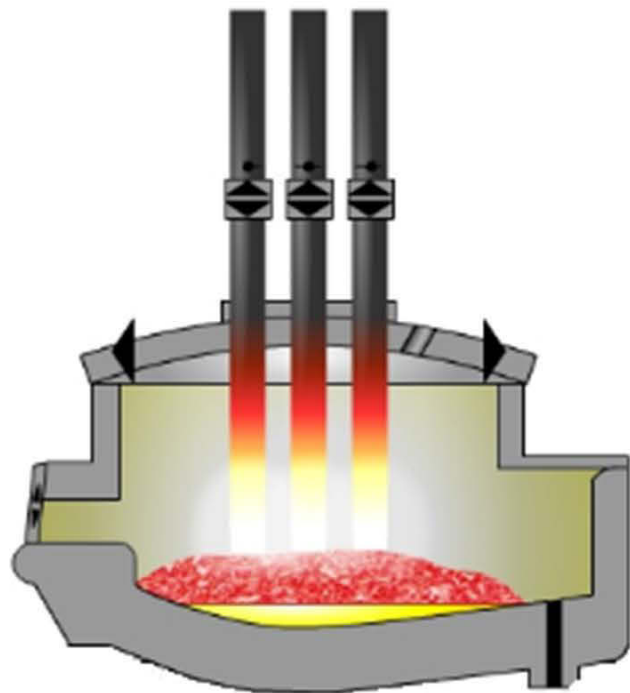

EAF

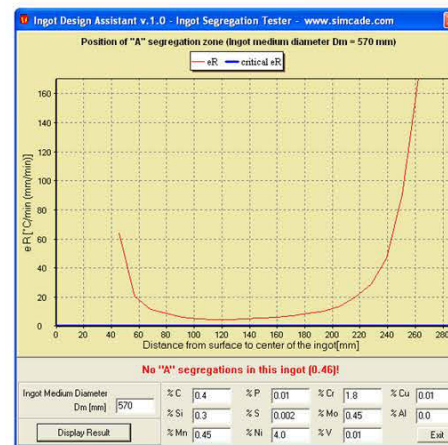

Macro segregation prediction

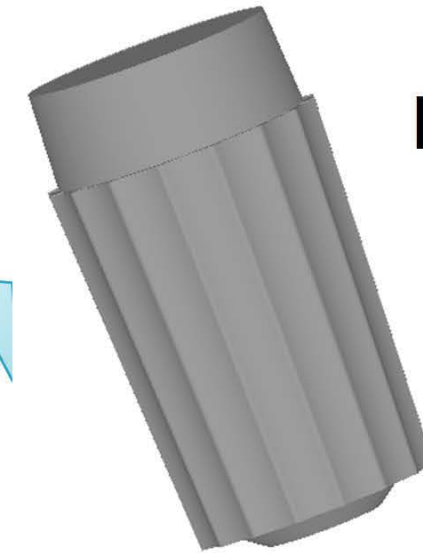
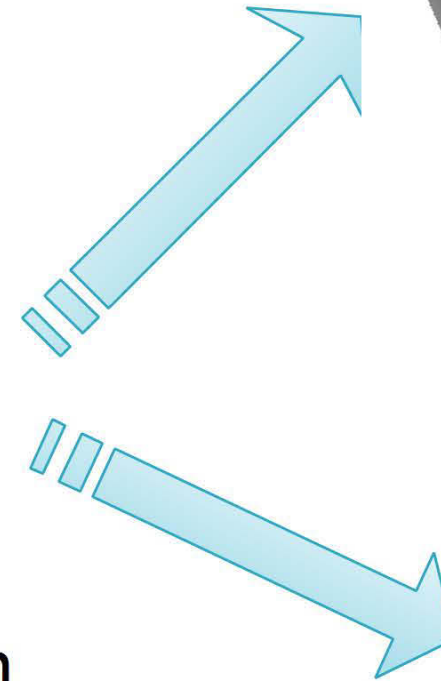

Ingot weight  
50T

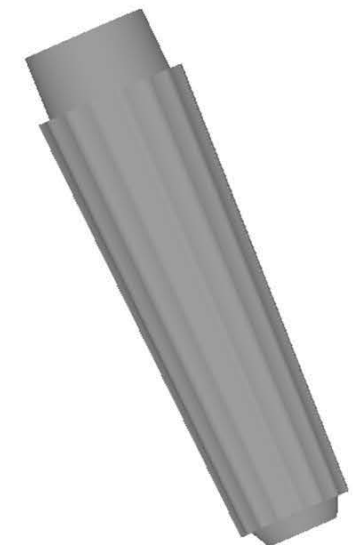
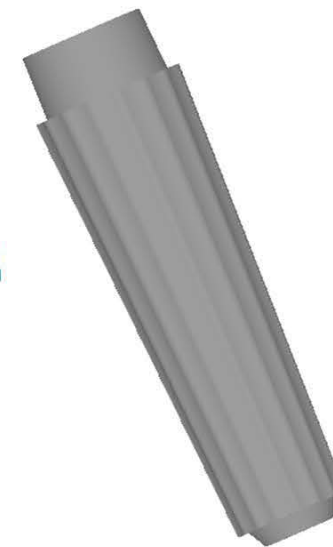

Ingot weight  
2 x 25T

Table 1. Chemical composition of 35NCD16 steel

%C	%Si	%Mn	%Cr	%Mo	%Ni
0.32~	0.10~	0.30~	1.60~	0.25~	3.60~4.1
0.39	0.40	0.60	2.00	0.45	

## 4.5 Macro Segregation Prediction in Quality Control

Using segregation prediction, it can be generated a quality certificate with information about position, area size and intensity of macro segregation for a particular ingot size and steel, information useful in forging technology conception.

See the next page for an example of a such certificate.

# Quality Control Certificate Example

## Macro Segregation Control Analysis

000030 / 30 August 2011

### Customer:

XXXXXXXXXXXXXXXXXXXXX  
XXXXXXXX XXXXX  
XXXXXXXX XXX  
XXXX XXXXX XXXXX XX XXXXXXX  
+XX XXXX XXXXX  
XXXXXXXX@XXXXXXXXXXXX.XXX

**Method of analysis:** Non destructive control using simulation software

**Simulation software employed:** SimCADE v.2.0

**Criteria method:** Suzuki and Miyamoto

**Part type:** Ingot

**Heat no:** R8703

**Ingot size:** 47 Dm: 1194mm (47")

**Melt no:** 39206

**Ingot weight:** 18.0tons (39760lb)

**Steel grade:** 4330V

### Chemical composition:

%C	%Si	%Mn	%P	%S	%Ni	%Cr	%Mo	%V
0.32	0.28	0.93	0.008	0.007	1.70	1.01	0.43	0.084

## Macro Segregation Control Analysis Result:

The material is not homogeneous and contains macro segregation.

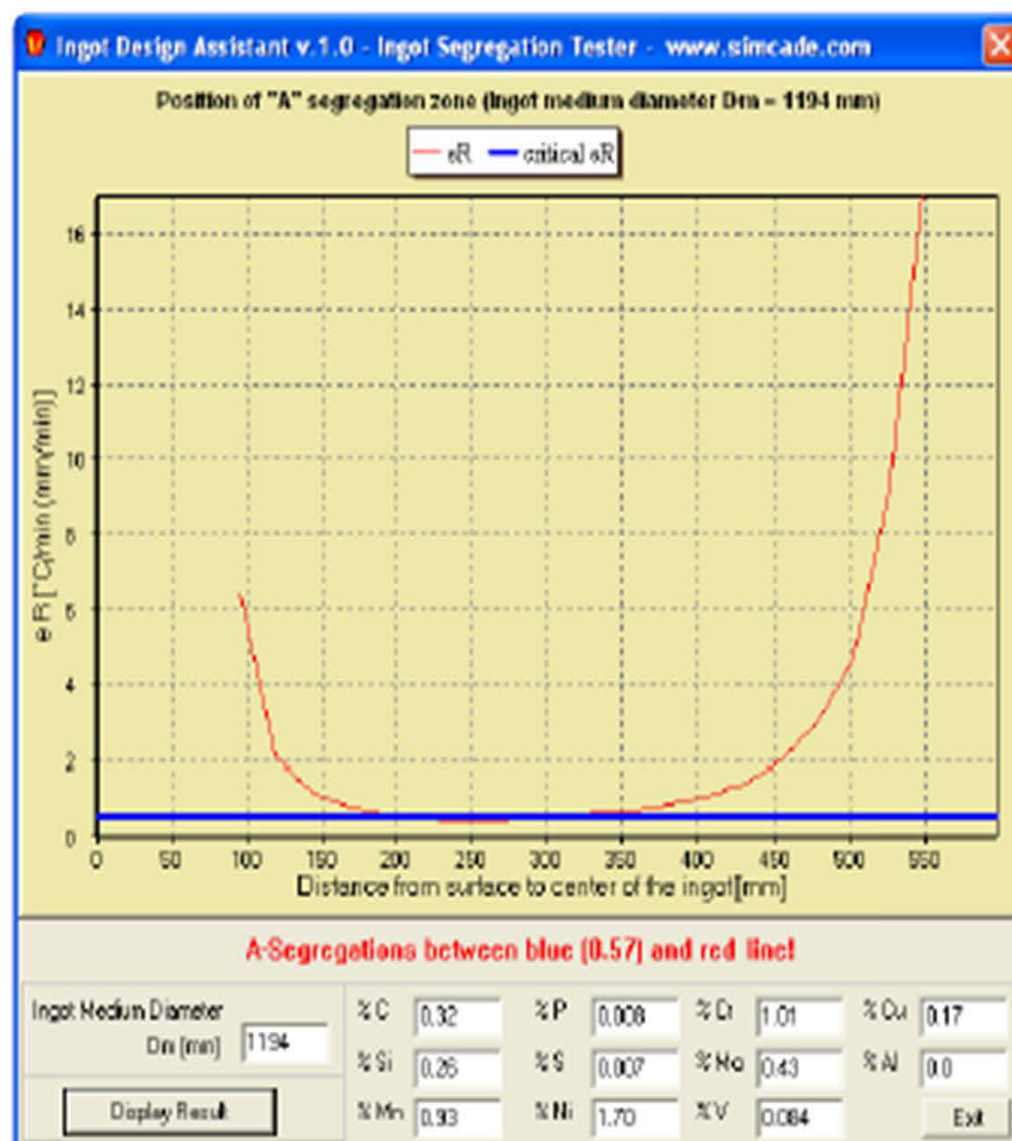
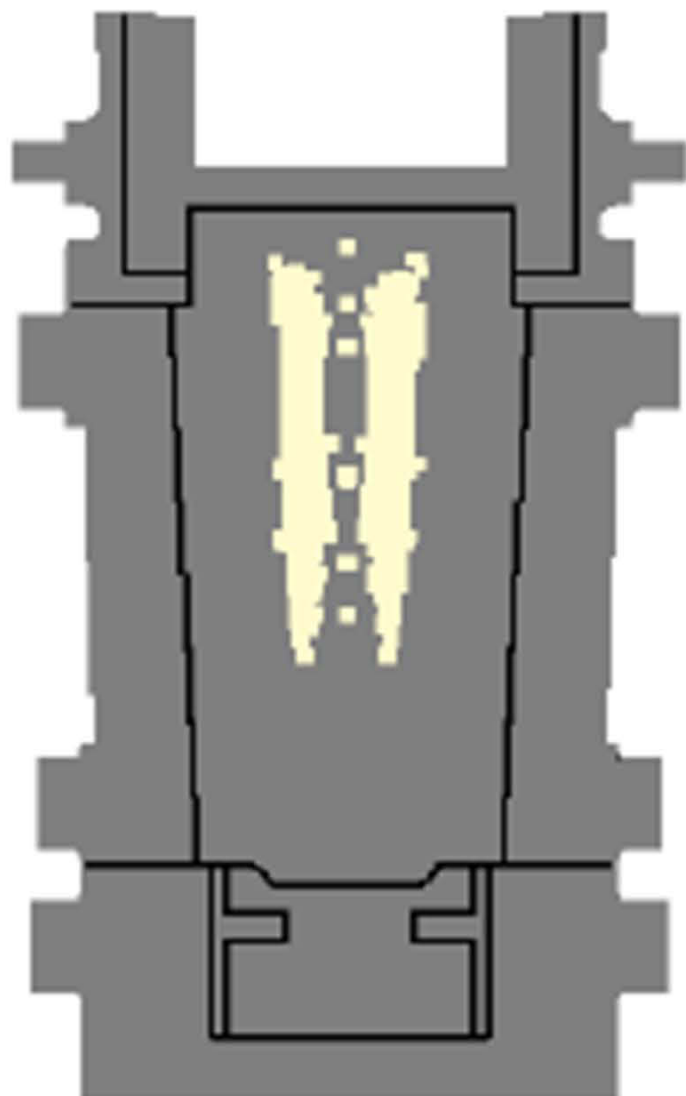

## 4.6 Macro Segregation Prediction and Steel Ingot Acquisition

This example is about how to use the macro segregation prediction if you like to acquire a steel ingot.

Macro segregation prediction can tell you if an ingot with a particular geometry and chemical composition is free of macro segregation or not.

The ingot on the next page, has a very large macro segregation zone and is not recommended to use it for making high quality forgings.

The second one has the macro segregation area size almost zero and it can be used to manufacture forgings with high quality.



# Forging Ingot Acquisition - Examples

## Macro segregation in 63\* size ingot

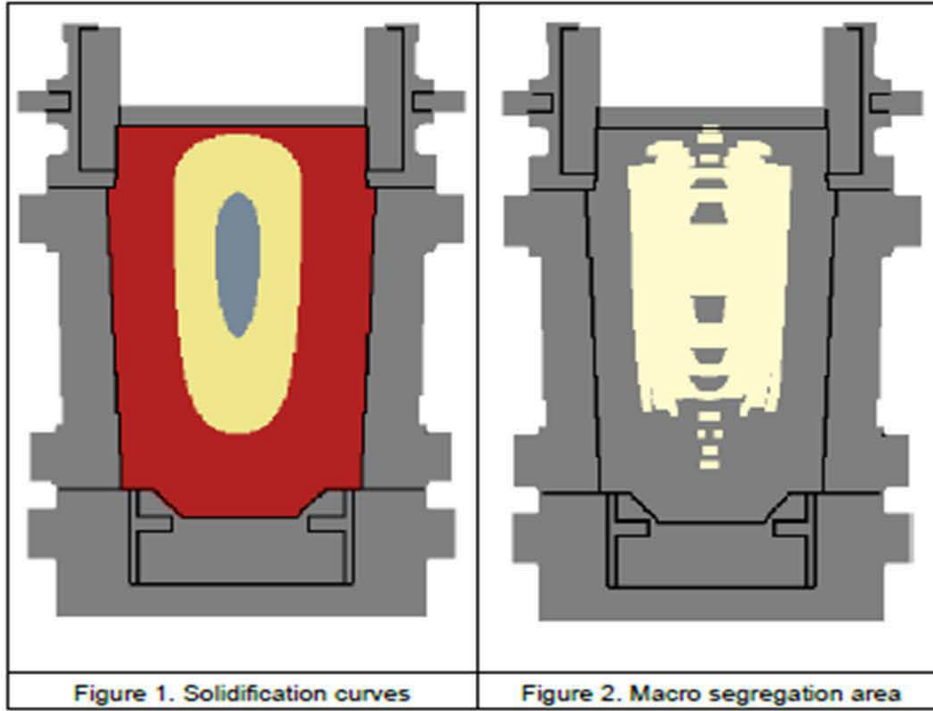

Ingot weight: 38.8T  
4330V Steel

Part type: Ingot Heat no: T5583  
Ingot size: 63 Dm: 1600mm (63") Melt no: 43474  
Ingot weight: 38.8tons (85600lb)

Steel grade: 4330V  
Chemical composition:

%C	%Si	%Mn	%P	%S	%Ni	%Cr	%Mo	%V
0.30	0.33	0.92	0.017	0.013	1.74	0.91	0.39	0.088

## Macro segregation in 36 size ingot

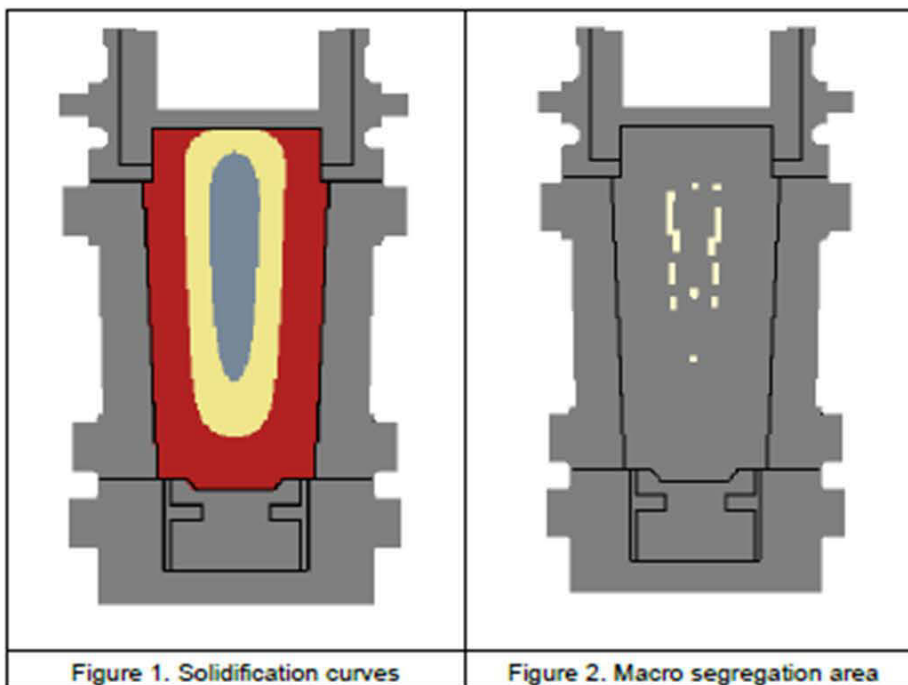

Ingot weight: 10.6T  
4330V steel

Part type: Ingot Heat no: P3978  
Ingot size: 36 Dm: 914mm (36") Melt no: 22751  
Ingot weight: 10.6tons (23480lb)

Steel grade: 4330V  
Chemical composition:

%C	%Si	%Mn	%P	%S	%Ni	%Cr	%Mo	%V
0.31	0.28	0.83	0.011	0.003	1.90	0.87	0.47	0.088

## 5 Macro Segregation Control Service

Based on solidification simulation software and macro segregation control technique presented in this paper, Industrial Soft offers the following services:

- 1 Forgings and ingot non destructive testing for macro segregation
- 2 Technical support at the acquisition of steel forging ingots
- 3 Technical support for choosing ingot size and geometry function by steel grade
- 4 Technical support for choosing a target chemical composition for a particular ingot size and steel grade
- 5 Technical support and implementation of macro segregation prediction technique
- 6 Manufacturing variables analysis and macro segregation prediction for a particular steel grade and ingot geometry
- 7 Mold assembly projects for hollow or big ingots
- 8 Selling ingots and bars on [www.castingsnet.com](http://www.castingsnet.com)

# 50T Mold Assembly Project Example

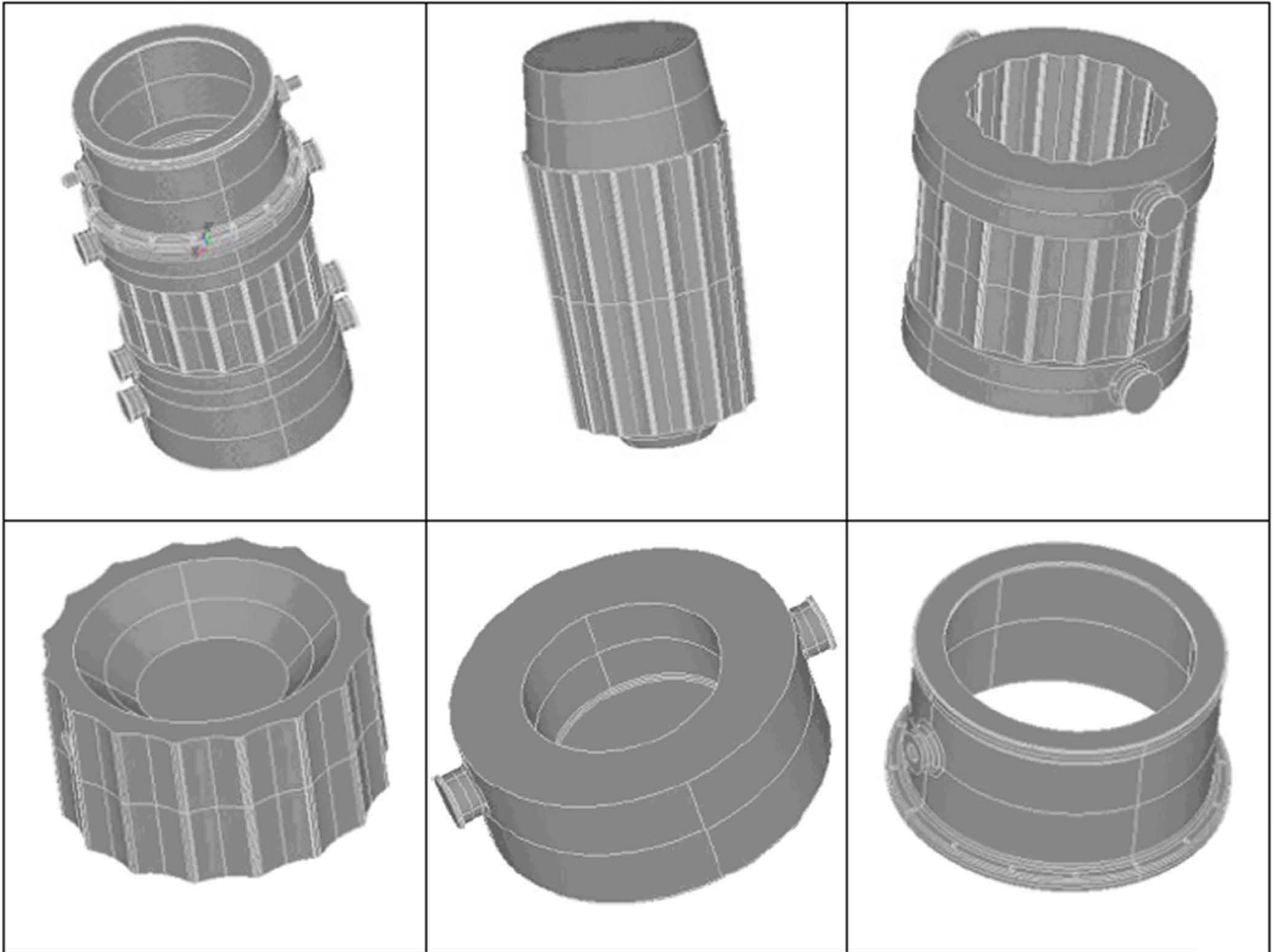

**Industrial Soft** is a cost effective engineering and software development company **specialized in metal industry applications**. We are located in **Montreal, Canada** but we can serve you wherever you are in the world. We provide the following products and services:

## 1. Castings solidification simulation service. Porosity prediction

Numerical simulation of the solidification process enables you to evaluate the casting design technology before committing to expensive pattern or die manufacture. We use Niyama criteria to predict porosity in aluminum and steel castings.

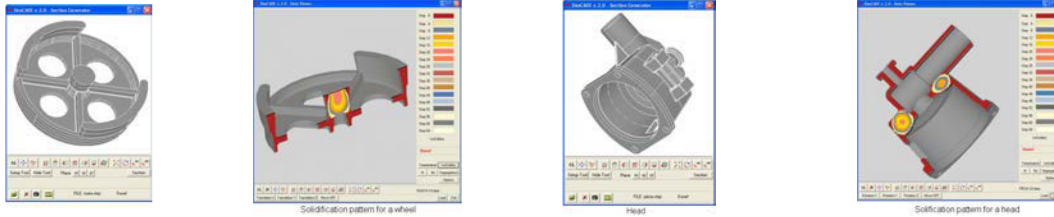

## 2. Ingot solidification simulation service. A-segregation prediction

This service allows you to check if the ingot size, shape and chemical composition of steel poured are appropriate to minimize A-segregations detected by ultrasonic test and increase the homogeneity of mechanical properties.

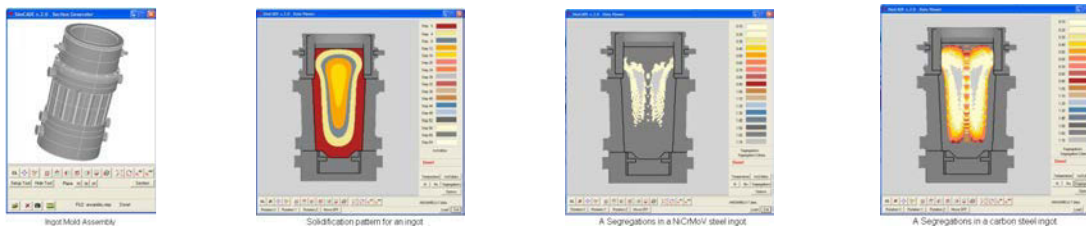

## 3. Mold assembly projects for big and small ingots

This service provides a complete mold assembly project for pouring ingots up to 350 tons. Also, we offer projects for hollow ingots or 2, 4 or 8 bottom poured ingots. The size and shape of the ingots will be chosen according to the steel type poured and the forging size in order to minimize A-segregations type defects. Contact us if you need more info about this service.



## 4. Custom software for design, engineering, scientific, database and online applications

Our software comes with simple and easy installation programs, intuitive graphical user interface, and informative help files with instruction manuals.

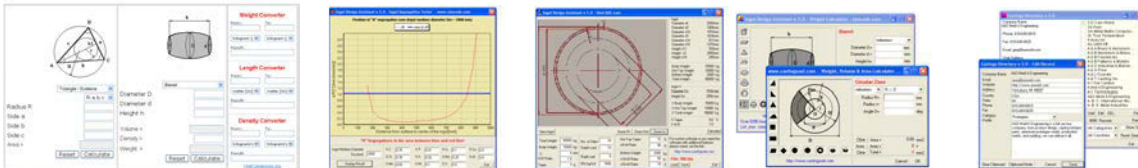

## 5. Upgrade or customize your existing software

We have expertise in re-writing, modifying and debugging software code for design, engineering, scientific, databases and online applications using following languages:

- engineering and scientific applications (Visual C++, Visual Basic, Pascal);
- databases applications (MySQL, sqlite3, Visual Fox, DBase, Access);
- online applications (PHP, HTML, JavaScript, Ajax, Flex).

## 6. Online advertising on castingsnet.com and website design - <http://castingsnet.com/premium.htm>



**castingsnet.com**, online since 1999, is the biggest online directory and search engine that lists foundries, foundry equipment and foundry supplies. If you already own a website, we offer cost effective advertising on our online directory; if not, we can build a website that will inform people about your products and services and serve as a 24/7 advertisement for your company. To increase the visibility of your company, we list your website on castingsnet.com for free of charge.

## 7. Castings Directory v.5.0 – CD-ROM – <http://castingsnet.com/cdrom.htm>

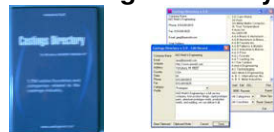

Castings Directory 5.0 is the CD-ROM version of our online search engine for foundries and related companies – **castingsnet.com** Very simple and easy to use, even by people with only basic computer skills, the software provides virtually instant access to over 8.200 worldwide foundries, foundry equipment and foundry supplies.